

PrimeLine® weatherboard

A pre-primed, site-painted weatherboard, available in a range of profiles from contemporary to traditional. The range includes the following weatherboards:

PrimeLine® Summit. A slender, beaded-edge weatherboard with a strong lap line. Compatible with the HardieLock™ fixing system.

PrimeLine® Heritage. A double-width weatherboard with rebated edges to create shadow lines

PrimeLine® Newport. A smooth, narrow weatherboard. Compatible with the HardieLock™ fixing system

PrimeLine® Chamfer. A double-width weatherboard with clean lines to create a shadow effect.

Where do you use it?

As an external cladding in residential single and medium-density homes, including alterations and additions, where a traditional or contemporary weatherboard look is required. Ideal for full wrap or composite construction designs on either timber or light gauge steel framed homes.

What are the key benefits?

Affordability. PrimeLine weatherboard is pre-primed with a milled finish, making it easy to paint, and reducing the finishing time and cost.*

Design flexibility. A wide variety of looks, from contemporary to traditional, can be achieved with the varying profiles in the range.

Fast installation. Both the Summit and Newport profiles come with the HardieLock™ fixing system, which minimises the time needed to set out the boards. The PVC HardieLock spline that runs along the back of these profiles fits neatly over the lower board, locking it securely into position. Added to this, it enables off-stud joining, which minimises wastage and allows fasteners to be concealed, which enhances the finished look. Chamfer and Heritage profiles come in a double-width board, which allows faster wall coverage, and off-stud joining is possible with the PrimeLine® Universal Off Stud Joint Clip accessory.

Security. PrimeLine weatherboard is resistant to damage from termites, rot and fire.

A 25-year product warranty gives peace of mind. Added to this, both Taubmans and Wattyl provide a 15-year paint warranty on selected paints when applied to PrimeLine weatherboard.

Available sizes

Profile	Width (mm)	Length (mm)	Thickness (mm)	Mass (kg/m ²)
Summit	230	4200	9	3.3
Heritage	300			4.3
Newport	170			2.5
Chamfer	300			4.3

PrimeLine® Summit weatherboard pre-primed board with slender beaded edge and strong lap line; HardieLock® fixing system.



PrimeLine® Heritage weatherboard pre-primed double board width, with rebated edge to create shadow lines.

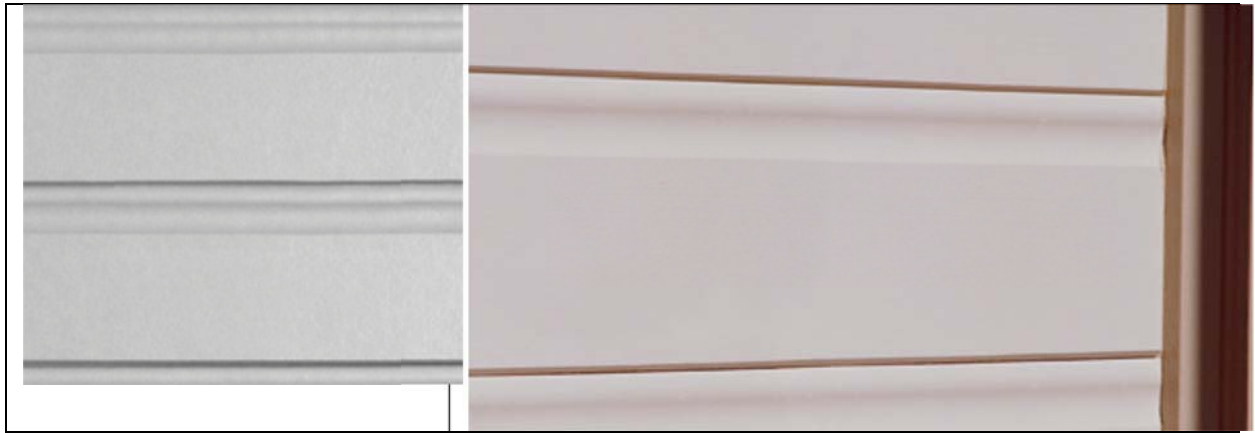



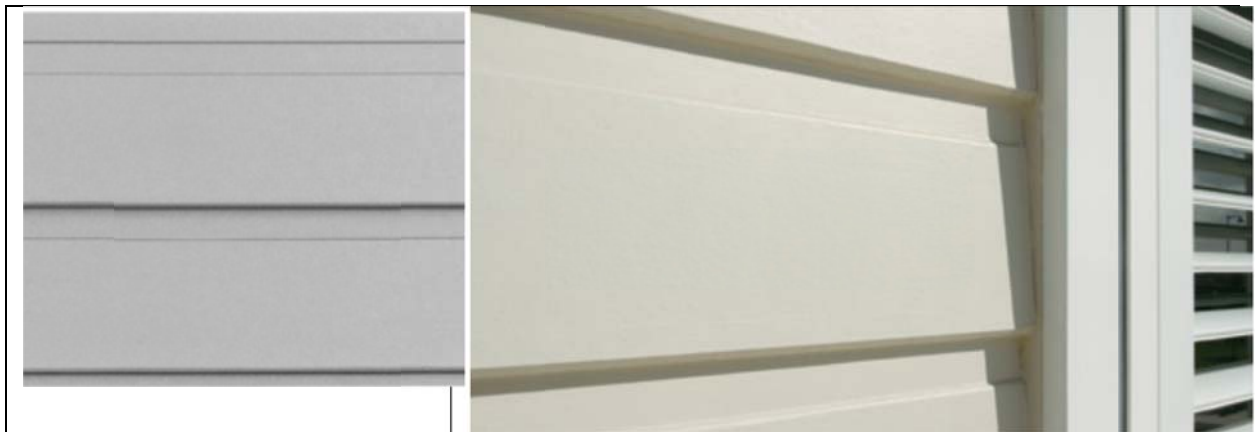

PrimeLine® Newport weatherboard pre-primed smooth, narrow board; HardieLock® fixing system.

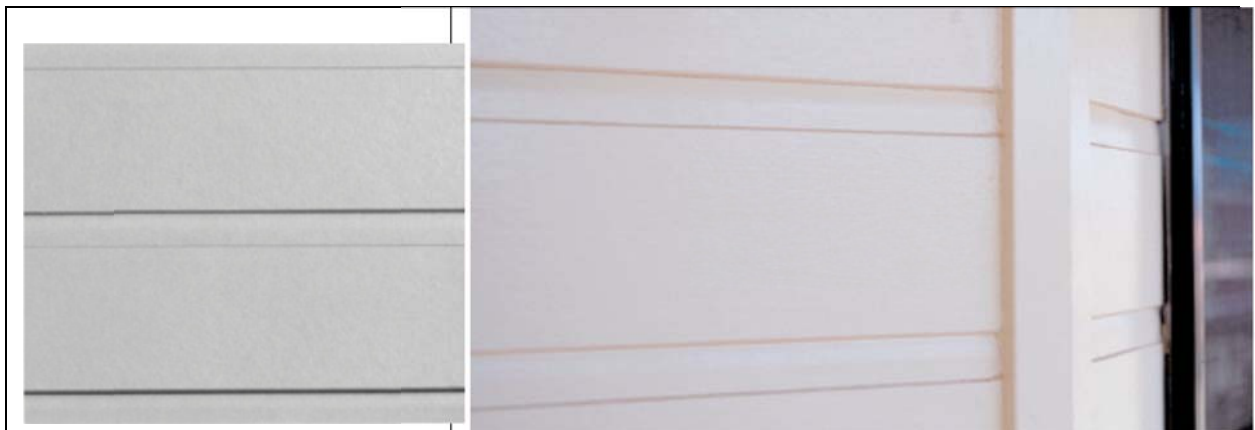

PrimeLine® Chamfer weatherboard pre-primed double board width, with clean lines to create shadow effect.

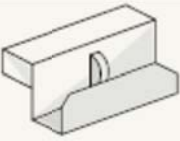
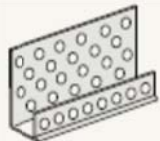
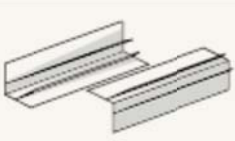

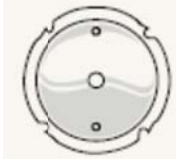
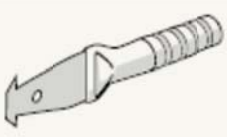
Accessories

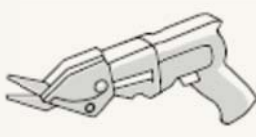
PrimeLine® Galvanised Universal Off Stud Joint Clip	James Hardie™ 7.5mm PVC Starter Strip	James Hardie™ Aluminium Snap On Corner	HardieDrive™ Screws 32mm long
			
<p>A galvanised metal clip to be used for off stud jointing of PrimeLine® Heritage and PrimeLine® Chamfer weatherboards.</p>	<p>A perforated PVC extrusion, used with HardieTex™ sheet to provide a straight edge to finish the texture coating or used with PrimeLine® Newport or Summit weatherboard to secure the bottom row at the correct angle. Length: 3000mm</p>	<p>A ready to paint aluminium extrusion set, to be used with Scyon™ Axon™ cladding, HardiePlank™ weatherboard and PrimeLine® weatherboard, at internal and external corner junctions to conceal the board edge. Length: 3000mm (2 pieces per set).</p>	<p>A class 3 finish self-tapping wing-tipped screw for fastening to 0.8mm to 1.6mm BTM steel frames</p>
HardieBlade™ Saw Blade	James Hardie™ Score and Snap Knife	James Hardie™ Joint Sealant	James Hardie™ Fibreshears
			
<p>A 185mm or 254mm diameter poly-diamond blade for fast and clean cutting of James Hardie fibre cement</p>	<p>A tungsten tipped knife for scoring fibre cement sheets.</p>	<p>A general purpose, paintable, exterior grade polyurethane joint sealant.</p>	<p>Electric tool for cutting fibre cement sheets.</p>

Installing first PrimeLine® Summit or Newport weatherboard

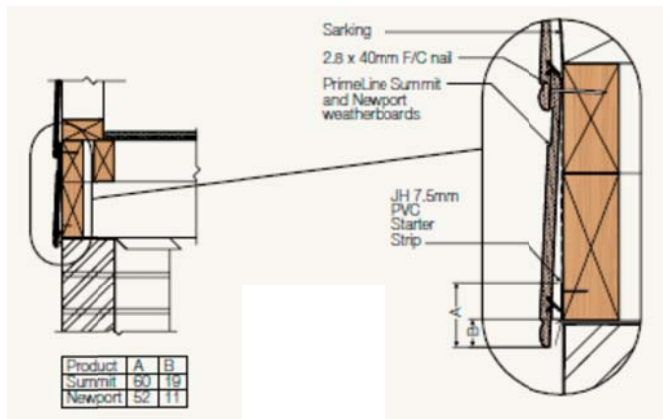

Internal corner

